

ABB General Machinery Drives

ACS350, 0.5 to 30 Hp

Technical Catalog

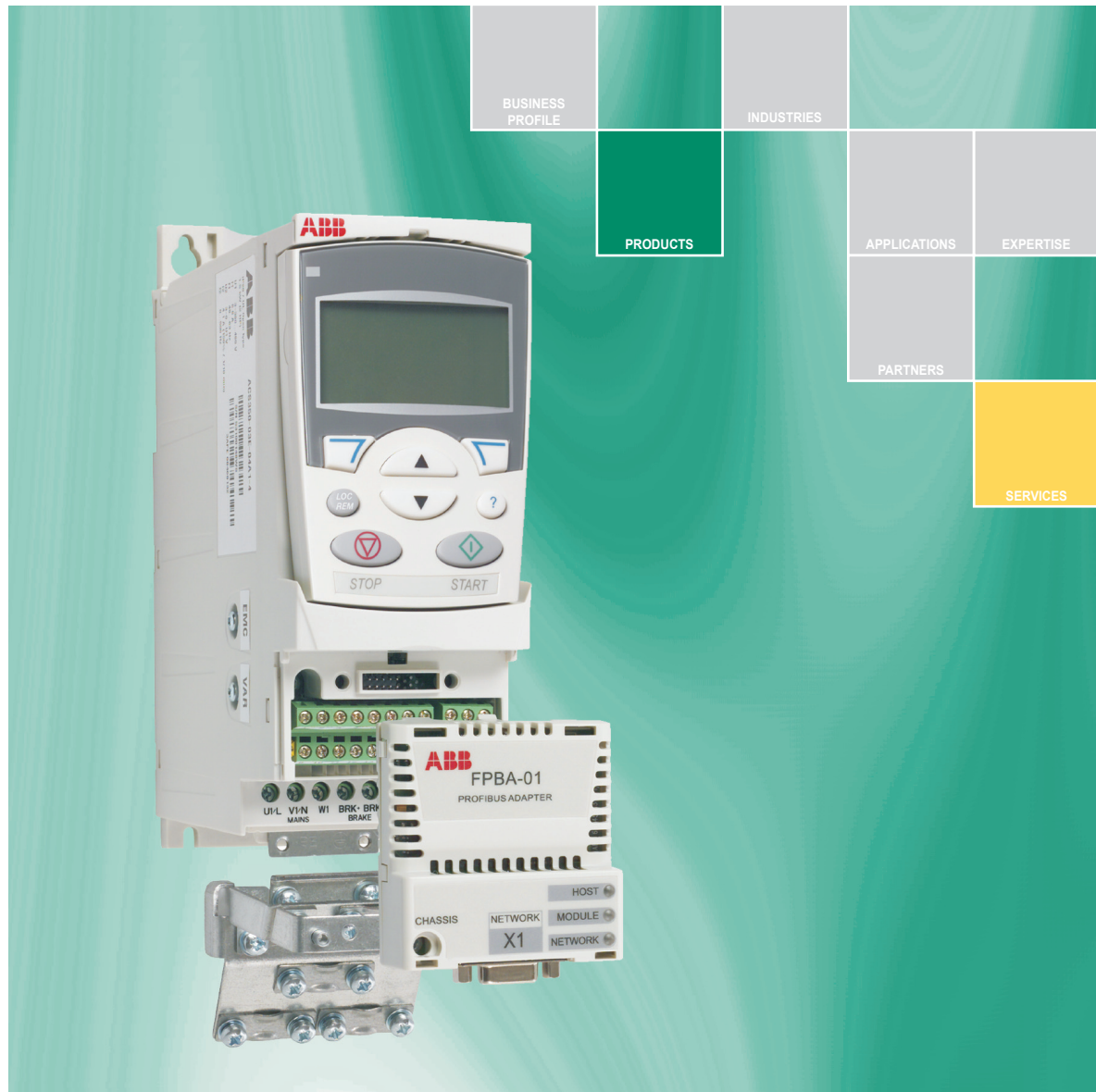

Contents



Choice 1: Simply contact your local ABB drives sales office and let them know what you want. Use page 4 as a reference **OR**

Choice 2: Build up your own ordering code using the simple 7-step approach below. Then, contact your local ABB Drives sales office.





ABB General Machinery Drive, ACS350

ABB General Machinery Drives	4	1
Features	4	
Technical Specification	5	
Output current rating	6	2
Input voltage rating	6	3
Phases.....	6	4
Electro Magnetic Compatibility (EMC).....	6	
Dimensions.....	7	5
How to select options	7	6
Interfaces		
User interfaces	8	
Machine interfaces	9	
External options		
Brake resistors	10	
FlashDrop.....	10	
Software tools		
DriveWindow Light 2.x.....	11	
Cooling	12	7
Fuse selections.....	12	
Connection examples	13	

ABB General Machinery Drives

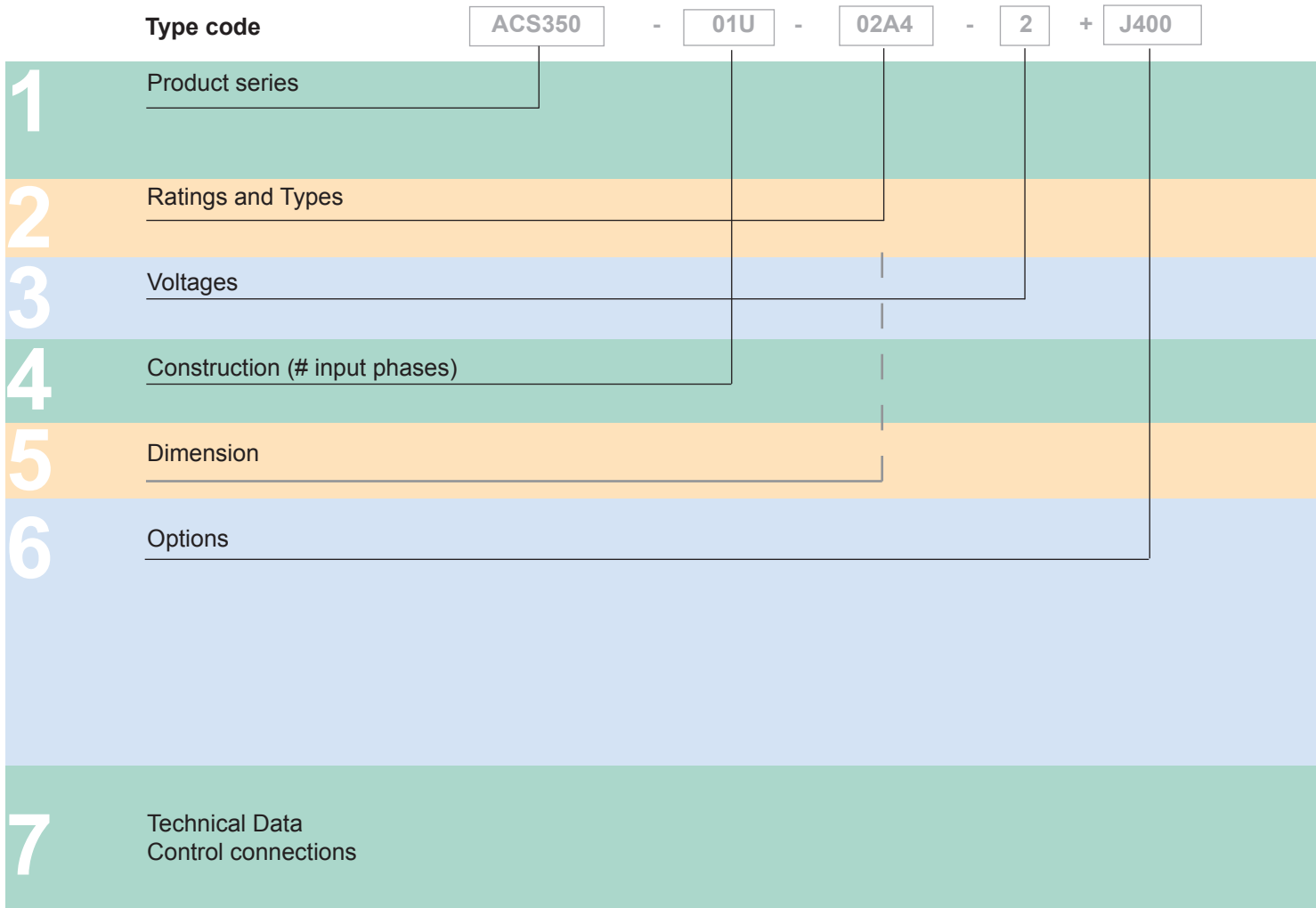

ACS350 - 01U - 02A4 - 2 + J400

What is the ACS350 Customer Value?

- Dramatically reduces programming time and costs with FlashDrop
- Optimal installation layout with unified height and depth for all frames and DIN rail mounting up to 30 Hp
- Reduced cost with built-in brake chopper and EMC filter
- Reduced wiring time and costs for easy access I/O and plug-in Fieldbus modules
- Increased standard or custom programming capacity, flexibility and capabilities for simple to complex motor control with:
 - Built-in intelligent triggering
 - Supervising parameters
 - Speed compensation
 - User specified macros
 - PLC-like functions
 - Reference trim

The ABB ACS350 general machinery drive is designed specifically for the OEM machine-building sector. In this sector, the manufacturing time per unit is critical. The ACS350 is designed to be the fastest drive in terms of installation, setting parameters and commissioning. The ACS350 has been designed to be as user-friendly as possible, yet provide high application flexibility. The ACS350 offers diverse functionality to cater to the most demanding needs.

Where can it be used?

ABB general machinery drives are designed to meet the requirements of an extensive range of machinery applications. The drive is ideal for food and beverage, material handling, textile, printing, rubber and plastics, and woodworking applications.

Highlights

- FlashDrop
- Sensorless Vector Motor Control
- Sequence programming
- Impressive software and compact hardware
- Optimized interfaces for users and machines
- Unified height and depth
- Convenient installation
- Coated boards as standard
- Built-in brake chopper as standard
- RoHS (verify label)

What are the ACS350's Main Features and Benefits supporting Customer Value?

Features	Benefits	Notes
FlashDrop	Faster and easier drive set up and commissioning.	New fast, safe and trouble free method to download parameters available without electricity - Patented.
Sequence programming	Logic programming included as standard with PLC-like functions.	Application specific 8-state programming with comprehensive triggering conditions.
Software	State of the art technology and performance with exceptional flexibility.	Sensorless vector and closed loop vector control
User interfaces	Cost efficient approach offering different control panels according to functionality need.	Blank cover Basic panel with numerical display Advanced control panel with clear alphanumerical dynamic menus, real time clock and 14 languages.
Cabinet compatibility	Optimum installation layout and efficient cabinet space usage.	Screw, DIN-rail, sideways and side-by-side mounting. Unified height and depth.
Fieldbuses	High speed communication with compact and robust fieldbus design.	Enclosed plug-in type of fieldbus adapter.
Built-in EMC filter	No extra space, parts, time or cost required.	2 nd environment filter complying with IEC 61800-3 as standard.
Coated boards	Longer lifetime in hostile environments. Reduced service.	Protections against moisture and hostile particles as standard.
Built-in Brake Chopper	Reduced costs, saved space and simple wiring.	100% braking capability
Drive Protection	Latest solutions to protect the drive and offer trouble-free use and the highest quality	Motor output and I/O protected against miswiring. Protection against unstable supply networks. Coated boards included as standard.

Technical Specification



ACS350 - 01U - 02A4 - 2 + J400

Input connection

Voltage and power range	1-phase, 200 to 240 V $\pm 10\%$ 0.37 to 2.2 kW (0.5 to 3 hp) 3-phase, 200 to 240 V $\pm 10\%$ 0.37 to 11 kW (0.5 to 15 hp) 3-phase, 380 to 480 V $\pm 10\%$ 0.37 to 22 kW (0.5 to 30 hp)
Frequency	48 to 63 Hz
Power factor	0.98

Output connection

Voltage	3-phase, from 0 to U_{SUPPLY}
Frequency	0 to 500 Hz
Continuous loading capability (constant torque at a max. ambient temperature of 40°C)	Rated output current I_{2N}
Overload capacity (at a max. ambient temperature of 40°C)	1.5 x I_{2N} for 1 minute every 10 minutes 1.8 x I_{2N} for 2 seconds every 10 minutes
Switching frequency	
Default	4 kHz
Selectable	4 to 12 kHz with 4 kHz steps (16 kHz, v 2.41+)
Acceleration time	0.1 to 1800 s
Deceleration time	0.1 to 1800 s
Braking	Brake chopper- standard (100% braking capability)
Speed Control	
Static Accuracy	20% of motor nominal slip
Dynamic Accuracy	<1% with 100% torque stop
Torque Control	
Torque step rise time	< 10ms with nominal torque
Non-linearity	$\pm 5\%$ with nominal torque

Environmental limits

Ambient temperature	-10 to 40°C (14 to 104°F), no frost allowed 50°C (122°F) with 10% derating
Altitude	
Output current	Rated current available at 0 to 1000 m (0 to 3281 ft) reduced by 1% per 100 m (328 ft) over 1000 to 2000 m (3281 to 6562 ft)
Relative humidity	Lower than 95% (without condensation)
Protection class	IP 20 / optional NEMA 1
Enclosure color	NCS 1502-Y, RAL 9002, PMS 420 C
Contamination levels	IEC 60721-3-(1,2,3) No conductive dust allowed
Transportation	Class 1C2 (chemical gases) Class 1S2 (solid particles)
Storage	Class 2C2 (chemical gases) Class 2S2 (solid particles)
Operation	Class 3C2 (chemical gases) Class 3S2 (solid particles)

Programmable control connections

Two analog inputs	
Voltage signal	
Unipolar	0 (2) to 10 V, $R_{in} > 312 \text{ k}\Omega$
Bipolar	-10 to 10 V, $R_{in} > 312 \text{ k}\Omega$
Current signal	
Unipolar	0 (4) to 20 mA, $R_{in} = 100 \Omega$
Bipolar	-20 to 20 mA, $R_{in} = 100 \Omega$
Potentiometer reference value (X1A:4)	10 V $\pm 1\%$ max. 10 mA, $R < 10 \text{ k}\Omega$
Resolution	0.1%
Accuracy	$\pm 1\%$
One analog output	0 (4) to 20 mA, load $< 500 \Omega$
Auxiliary voltage	24 V DC $\pm 10\%$, max. 200 mA
Five digital inputs	12 to 24 V DC with internal or external supply, PNP and NPN, pulse train 0 to 16 kHz
Input impedance	2.4 k Ω
One relay output	
Type	NO + NC
Maximum switching voltage	250 V AC/30 V DC
Maximum switching current	0.5 A/30 V DC; 5 A/230 V AC
Maximum continuous current	2 A rms
One digital output	
Type	Transistor output
Maximum switching voltage	30 V DC
Maximum switching current	100 mA/30 V DC, short circuit protected
Frequency	10Hz to 16 kHz
Resolution	1 Hz
Accuracy	0.2%

Serial communication

Fieldbuses	Plug-in type
Refresh rate	< 10 ms (between drive and fieldbus module)
PROFIBUS DP ®	9-pin D-connector Baud rate up to 12 Mbit/s PROFIBUS DP and PROFIBUS DPV1 Network side based on "PROFIdrive" profile.
DeviceNet ™	5-pin screw type connector Baud rate up to 500 kbit/s Network side based on ODVA "AC/DC drive" profile.
CANopen	9-pin D-connector Baud rate up to 1 Mbit/s Network side based on CiA DS402 profile.
Modbus RTU ®	4-pin screw type connector Baud rate up to 115 kbit/s

Product compliance

Low Voltage Directive 73/23/EEC with supplements
Machinery Directive 98/37/EC
EMC Directive 89/336/EEC with supplements
Quality assurance system ISO 9001
Environmental system ISO 14001
UL, cUL, CE, C-Tick and GOST-R approvals
RoHs (Verify RoHS label)
IEC/EN 61800-5-1 (2003)
IEC/EN 60204-1 (1999)
IEC/EN 61800-3 (2004)

Ratings, Types, Voltages and Construction



ACS350 - 01U - 02A4 - 2 + J400

EMC according to EN61800-3

2nd environment, unrestricted distribution (C3),
Filter inbuilt as standard, maximum cable length 30 m
1st environment, restricted distribution (C2), Filter as an option,
cable lengths depend on the frame size and switching frequency.

EMC Standards in general

EN 61800-3/A11 (2000), product standard	EN 61800-3 (2004), product standard	EN 55011, product family standard for industrial, scientific and medical (ISM) equipment
1st environment, unrestricted distribution	Category C1	Group 1 Class B
1st environment, restricted distribution	Category C2	Group 1 Class A
2nd environment, unrestricted distribution	Category C3	Group 2 Class A
2nd environment, restricted distribution	Category C4	Not applicable

Type code

This is a unique reference number that clearly identifies the drive by power rating, voltage, and construction. Once you have selected the type code, the frame size can be used to determine the drive dimensions, shown on the next page.

Voltages

The ACS350 is available in two voltage ranges:

2 = 200 - 240 V

4 = 380 - 480 V

Construction

"01U" or the "03U" within the type code indicates the number of input phases for the power and EMC filtering.

01 = 1-phase (200 - 240V only)

03 = 3-phase (200 - 240V and 380 - 480V)

U = EMC filter disconnected, 60 Hz motor data
(In case the filter is required, it can easily be connected.)

Type code	Frame size	Ratings		
		P _N kW	P _N hp	I _{2N} A
1-phase supply voltage 200 - 240 V units				
ACS350-01U-02A4-2	R0	0.37	0.5	2.4
ACS350-01U-04A7-2	R1	0.75	1.0	4.7
ACS350-01U-06A7-2	R1	1.1	1.5	6.7
ACS350-01U-07A5-2	R2	1.5	2.0	7.5
ACS350-01U-09A8-2	R2	2.2	3.0	9.8
3-phase supply voltage 200 - 240 V units				
ACS350-03U-02A4-2	R0	0.37	0.5	2.4
ACS350-03U-03A5-2	R0	0.55	0.75	3.5
ACS350-03U-04A7-2	R1	0.75	1.0	4.7
ACS350-03U-06A7-2	R1	1.1	1.5	6.7
ACS350-03U-07A5-2	R1	1.5	2.0	7.5
ACS350-03U-09A8-2	R2	2.2	3.0	9.8
ACS350-03U-17A6-2	R2	4.0	5.0	17.6
ACS350-03U-24A4-2	R3	5.5	7.5	24.4
ACS350-03U-31A0-2	R4	7.5	10.0	31.0
ACS350-03U-46A2-2	R4	11.0	15.0	46.2
3-phase supply voltage 380 - 480 V units				
ACS350-03U-01A2-4	R0	0.37	0.5	1.2
ACS350-03U-01A9-4	R0	0.55	0.75	1.9
ACS350-03U-02A4-4	R1	0.75	1.0	2.4
ACS350-03U-03A3-4	R1	1.1	1.5	3.3
ACS350-03U-04A1-4	R1	1.5	2.0	4.1
ACS350-03U-05A6-4	R1	2.2	3.0	5.6
ACS350-03U-08A8-4	R1	4.0	5.0	8.8
ACS350-03U-12A5-4	R3	5.5	7.5	12.5
ACS350-03U-15A6-4	R3	7.5	10.0	15.6
ACS350-03U-23A1-4	R3	11.0	15.0	23.1
ACS350-03U-31A0-4	R4	15.0	20.0	31.0
ACS350-03U-38A0-4	R4	18.5	25.0	38.0
ACS350-03U-44A0-4	R4	22.0	30.0	44.0

Dimensions, Weight and Noise



ACS350 - 01U - 02A4 - 2 + J400

Cabinet-mounted drives (IP 20 UL open)

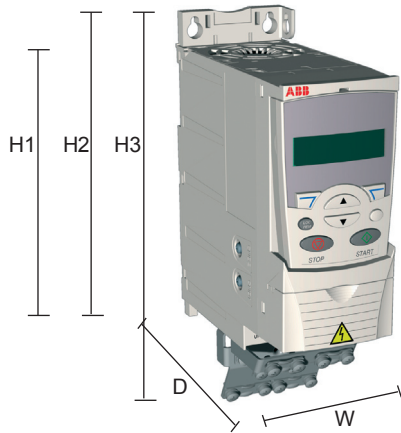

Frame Size	IP20 (cabinet) / UL Open						Noise level dBA
	H1 (in)	H2 (in)	H3 (in)	W (in)	D (in)	Weight (lb)	
R0	6.65	7.95	9.41	2.76	6.34	2.6	<30
R1	6.65	7.95	9.41	2.76	6.34	2.6	50...62
R2	6.65	7.95	9.41	4.13	6.50	3.3	50...62
R3	6.65	7.95	9.29	6.65	6.65	5.5	50...62
R4	7.13	7.95	9.61	10.24	6.65	9.7	<62

Wall-mounted drives (NEMA 1)

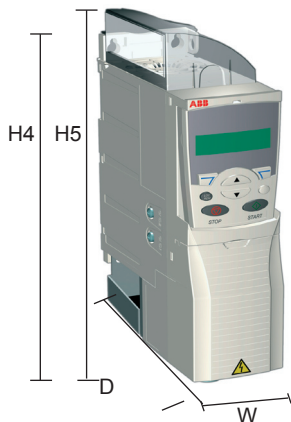

Frame Size	NEMA 1					Noise level dBA
	H4 (in)	H5 (in)	W (in)	D (in)	Weight (lb)	
R0	10.12	11.02	2.76	6.65	3.5	<30
R1	10.12	11.02	2.76	6.65	3.5	50...62
R2	10.12	11.10	4.13	6.65	4.2	50...62
R3	10.24	11.77	6.65	6.97	6.8	50...62
R4	10.63	12.60	10.24	6.97	11.0	<62

Options

How to select options

The options shown in the table are available with the ACS350. The factory configured option is a unique Plus Code, which is shown in the first column. This Plus Code is added to the end of the basic drive option code using a "+" code. Ordering the Field Kit Code provides a field installable kit shipped separately from the drive shipping package.

For example, an ACS350-03U-01A2-4+J400 would be a base drive with an Advanced Control Panel included in the drives shipping package. Option descriptions are provided in the subsequent pages.

Selection table

Plus Code	Description	Field Kit Code
-	NEMA 1 (R0, R1, R2)	MUL1-R1
-	NEMA 1 (R3)	MUL1-R3
-	NEMA 1 (R4)	MUL1-R4
Control Panel		
+J400	Advanced Control Panel	ACS-CP-A
+J404	Basic Control Panel	ACS-CP-C
-	Panel Mounting Kit	ACS/H-CP-EXT
-	Panel Mounting Kit (IP66)	ACS/H-CP-EXT-IP66
Potentiometer		
+J402	Potentiometer	MPOT-01
Fieldbus		
+K451	DeviceNet™	FDNA-01-KIT
+K454	PROFIBUS® DP	FPBA-01-KIT
+K457	CANopen	FCAN-01-KIT
+K458	Modbus® RTU	FMBA-01-KIT
External Options		
-	FlashDrop tool	MFDT-01
-	Drive Window Light 2	Drive Window Light 2.x
-	Modbus® RTU PCB	FRSA-00
-	Cabinet Panel Mounting	OPMP-01
-	Pulse Encoder Interface	MTAC-01

NOTES:

H1 = Height without fastenings and clamping plate.

H2 = Height with fastenings but without clamping plate.

H3 = Height with fastenings and clamping plate.

H4 = Height with fastenings and NEMA 1 connection box.

H5 = Height with fastenings, NEMA 1 connection box and hood.

W = Width

D = Depth



Options

ACS350 - 01U - 02A4 - 2 + J400

User interfaces

Panel cover

The purpose of the panel cover is to protect the drive's connection surfaces. In addition, there are two alternative control panels available as options.

■ Basic control panel

The basic control panel features a single line numeric display. The panel can be used to control the drive, set the parameter values or copy them from one drive to another.

■ Advanced control panel

For easy drive programming, a detachable, multi-lingual alphanumeric advanced control panel is available. The control panel provides assistants and a built-in help function to guide the user. It includes a real time clock, which can be used during fault logging and in controlling the drive, such as start/stop. The control panel can be used for copying parameters for back up or for downloading to another drive. A large graphical display and soft keys make it extremely easy to navigate.

Potentiometer

Potentiometer MPOT-01 with two switches: start/stop and forward/reverse. Polarity (PNP or NPN) is selected with DIP switches. No external power source is needed for the potentiometer.

Panel mounting kits

The panel mounting kits enable mounting of control panels on cabinet doors. They include a 3m extension cable, gasket, and all mounting hardware.

OPMP-01: Permits mounting of panel to external surface of NEMA 1 or NEMA 12 enclosures. The panel remains removable.

ACS/H-CP-EXT: permits permanent mounting of panel to external surface of NEMA 1 or NEMA 12 enclosures.

ACS/H-CP-EXT-IP66: permits permanent mounting of panel to external surface of NEMA 4x enclosures.

FlashDrop (MFDT-01)

FlashDrop is a powerful palm sized tool for fast and easy parameter selecting and setting. This tool can be used to download parameters to a drive in less than three seconds. Using this tool, it is also possible to hide selected parameters to protect the machine. Only the parameters needed in the application are shown. FlashDrop does not require the drive to be powered. The drives shipping container is also designed to allow use of the FlashDrop tool without removing the drive. The MFDT-01 includes the DrivePM (Drive Parameter Manager) software tool to create, edit and copy parameter sets.



FlashDrop (MFDT-01)



Panel cover



Basic control panel

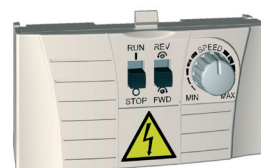

Potentiometer



Advanced control panel

Options



ACS350 - 01U - 02A4 - 2 + J400



Plug-in fieldbus module

NEMA 1 KIT

Machine interfaces

Plug-in fieldbus modules bring connectivity to major automation systems. A single twisted pair of wire avoids large amounts of conventional cabling, thereby reducing costs and increasing system reliability.

The ACS350 supports the following fieldbus protocols:

- CANopen
- DeviceNet™
- Built-in Modbus® RTU
- PROFIBUS® DP

Protection and installation

NEMA 1 kit

The NEMA 1 kit includes a conduit box and hood for protection against dirt and dust. Three kits are available to cover all frame sizes of the ACS350. MUL1-R1 covers frame sizes R0 through R2, MUL1-R3 covers frame size R3, and MUL1-R4 covers frame size R4.

Terminal Cover

The terminal cover is for protection of the I/O connections.

Clamping Plates

The clamping plates are used for protection against electrical disturbances when compliance to EMC is mandated. The clamping plates are included in the drive package as standard.

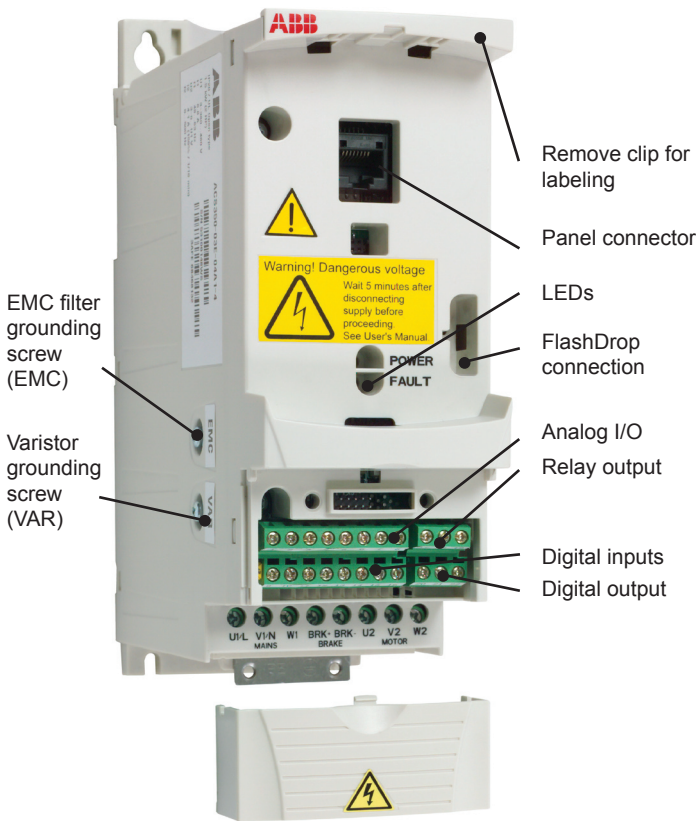

Terminal cover (included as standard)

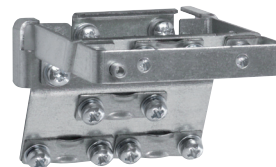

Clamping Plates (included as standard)

Options

External



A separate order line is required for any of these external options.

FlashDrop (MFDT-01)

FlashDrop is a powerful palm sized tool for fast and easy parameter selecting and setting. It provides the ability to hide selected parameters to protect the machine. Only the parameters needed in the application are shown. The tool can copy parameters between two drives or between a PC and a drive. All this can be accomplished without a power connection to the drive - in fact, it is not even necessary to unpack the drive.

DrivePM

DrivePM (Drive Parameter Manager) is a software tool to create, edit and copy parameter sets for FlashDrop. For each parameter/group the user has the ability to hide it, preventing the user from seeing the parameter or parameter group.

DrivePM requirements

- Windows 2000/XP
- Serial port from a PC

FlashDrop tool includes

- FlashDrop
- DrivePM software on a CD-Rom
- User's manual on CD-Rom
- Cable OPCA-02 for connection between the PC and FlashDrop
- Battery charger



Brake resistors

The brake resistor is selected using the table below. For more information about the selection of brake resistors, see the *ACS350 Price List (ACS350-PNPL01U-EN)*.

ACS350 is delivered with an integrated brake chopper as standard. Therefore, no additional space or installation time is needed.

Selection table

Type code	Frame size	P _{BRmax}		R _{min} ohm	R _{max} ohm
		P _N kW	P _N hp		
1-phase supply voltage 200 - 240 V units					
ACS350-01U-02A4-2	R0	0.37	0.5	70	390
ACS350-01U-04A7-2	R1	0.75	1.0	40	200
ACS350-01U-06A7-2	R1	1.1	1.5	40	130
ACS350-01U-07A5-2	R2	1.5	2.0	30	100
ACS350-01U-09A8-2	R2	2.2	3.0	30	70
3-phase supply voltage 200 - 240 V units					
ACS350-03U-02A4-2	R0	0.37	0.5	70	390
ACS350-03U-03A5-2	R0	0.55	0.75	70	260
ACS350-03U-04A7-2	R1	0.75	1.0	40	200
ACS350-03U-06A7-2	R1	1.1	1.5	40	130
ACS350-03U-07A5-2	R1	1.5	2.0	30	100
ACS350-03U-09A8-2	R2	2.2	3.0	30	70
ACS350-03U-17A6-2	R2	4.0	5.0	30	40
ACS350-03U-24A4-2	R3	5.5	7.5	18	25
ACS350-03U-31A0-2	R4	7.5	10.0	7	19
ACS350-03U-46A2-2	R4	11.0	15.0	7	13
3-phase supply voltage 380 - 480 V units					
ACS350-03U-01A2-4	R0	0.37	0.5	200	1180
ACS350-03U-01A9-4	R0	0.55	0.75	175	800
ACS350-03U-02A4-4	R1	0.75	1.0	165	590
ACS350-03U-03A3-4	R1	1.1	1.5	150	400
ACS350-03U-04A1-4	R1	1.5	2.0	130	300
ACS350-03U-05A6-4	R1	2.2	3.0	100	200
ACS350-03U-08A8-4	R1	4.0	5.0	70	110
ACS350-03U-12A5-4	R3	5.5	7.5	40	80
ACS350-03U-15A6-4	R3	7.5	10.0	40	60
ACS350-03U-23A1-4	R3	11.0	15.0	30	40
ACS350-03U-31A0-4	R4	15.0	20.0	16	29
ACS350-03U-38A0-4	R4	18.5	25.0	13	23
ACS350-03U-44A0-4	R4	22.0	30.0	13	19



Options

Software tools

A separate order line is required for any of these external options.

DriveWindow Light 2.x

DriveWindow Light 2.x is an easy-to-use start-up and maintenance tool for ACS350 drives. It can be used in an offline mode, enabling parameter setting at the office before going to the actual site. The parameter browser enables viewing, editing and saving of parameters. The parameter comparison feature makes it possible to compare parameter values between a drive and a saved file. With the parameter subset, you can create individual parameter sets. Controlling the drive is also available using DriveWindow Light. With DriveWindow Light, you can monitor up to four signals simultaneously both in graphical or numerical format. Any signal can be set to stop being monitored at a pre-defined level.

Sequence Programming Tool

For ACS350 drives, DriveWindow Light 2.x offers sequence programming. This tool is useful for setting the drive sequence programming parameters. The tool draws the program graphically on the PC screen showing used states, active state, transition conditions, possible transition delay as well as references and ramps.

Sequence programming enables application specific programming. This new and easy way to preset sequences reduces the need for an external programmable logic control (PLC).

Start-up Wizards

Start-up wizards make the setting of parameters easy. Simply launch the wizard, select an appropriate assistant (e.g. for setting analog outputs) and all parameters related to this function are shown together with help pictures.

Highlights

- Sequence programming tool for ACS350
- Editing, saving and downloading parameters
- Graphical and numerical signal monitoring
- Drive control
- Start-up wizards

DriveWindow Light requirements

- Windows NT/2000/XP
- Serial port from a PC

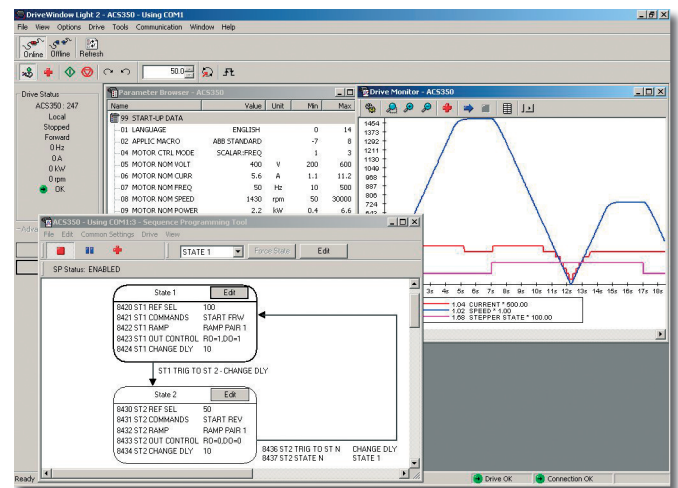



Cooling

The ACS350 is configured with cooling fans as standard. The cooling air must be free from corrosive materials and must not be above the maximum ambient temperature of 40°C (50°C with derating). For more specific limits see the Technical specification - Environmental limits in this catalog.

Cooling air flow

Type code	Frame size	Heat dissipation main circuit		Air flow	
		W	BTU/Hr	m ³ /h	ft ³ /min
1-phase supply voltage 200 - 240 V units					
ACS350-01U-02A4-2	R0	48	163	- *	- *
ACS350-01U-04A7-2	R1	72	247	24	14
ACS350-01U-06A7-2	R1	97	333	24	14
ACS350-01U-07A5-2	R2	101	343	21	12
ACS350-01U-09A8-2	R2	124	422	21	12
3-phase supply voltage 200 - 240 V units					
ACS350-03U-02A4-2	R0	42	142	- *	- *
ACS350-03U-03A5-2	R0	54	183	- *	- *
ACS350-03U-04A7-2	R1	64	220	24	14
ACS350-03U-06A7-2	R1	86	295	24	14
ACS350-03U-07A5-2	R1	88	302	21	12
ACS350-03U-09A8-2	R2	111	377	21	12
ACS350-03U-17A6-2	R2	180	613	52	31
ACS350-03U-24A4-2	R3	285	975	71	42
ACS350-03U-31A0-2	R4	328	1119	96	57
ACS350-03U-46A2-2	R4	488	1666	96	57
3-phase supply voltage 380 - 480 V units					
ACS350-03U-01A2-4	R0	35	121	- *	- *
ACS350-03U-01A9-4	R0	40	138	- *	- *
ACS350-03U-02A4-4	R1	50	170	13	8
ACS350-03U-03A3-4	R1	60	204	13	8
ACS350-03U-04A1-4	R1	69	235	13	8
ACS350-03U-05A6-4	R1	90	306	19	11
ACS350-03U-08A8-4	R1	127	433	24	14
ACS350-03U-12A5-4	R3	161	551	52	31
ACS350-03U-15A6-4	R3	204	697	52	31
ACS350-03U-23A1-4	R3	301	1029	71	42
ACS350-03U-31A0-4	R4	408	1393	96	57
ACS350-03U-38A0-4	R4	498	1700	96	57
ACS350-03U-44A0-4	R4	588	2007	96	57

*) Frame Size R0 with free convection cooling

Fuses

Standard fuses can be used with the ACS350. Recommended fuse ratings are shown in the table below.

Selection table

Type code	Frame size	IEC Fuses		UL Fuses	
		A	Fuse type ^{*)}	A	Fuse type ^{*)}
1-phase supply voltage 200 - 240 V units					
ACS350-01U-02A4-2	R0	10	gG	10	UL class T
ACS350-01U-04A7-2	R1	16	gG	20	UL class T
ACS350-01U-06A7-2	R1	20	gG	25	UL class T
ACS350-01U-07A5-2	R2	25	gG	30	UL class T
ACS350-01U-09A8-2	R2	35	gG	35	UL class T
3-phase supply voltage 200 - 240 V units					
ACS350-03U-02A4-2	R0	10	gG	10	UL class T
ACS350-03U-03A5-2	R0	10	gG	10	UL class T
ACS350-03U-04A7-2	R1	10	gG	15	UL class T
ACS350-03U-06A7-2	R1	16	gG	15	UL class T
ACS350-03U-07A5-2	R1	16	gG	15	UL class T
ACS350-03U-09A8-2	R2	16	gG	20	UL class T
ACS350-03U-17A6-2	R2	25	gG	35	UL class T
ACS350-03U-24A4-2	R3	63	gG	60	UL class T
ACS350-03U-31A0-2	R4	80	gG	80	UL class T
ACS350-03U-46A2-2	R4	100	gG	100	UL class T
3-phase supply voltage 380 - 480 V units					
ACS350-03U-01A2-4	R0	10	gG	10	UL class T
ACS350-03U-01A9-4	R0	10	gG	10	UL class T
ACS350-03U-02A4-4	R1	10	gG	10	UL class T
ACS350-03U-03A3-4	R1	10	gG	10	UL class T
ACS350-03U-04A1-4	R1	16	gG	15	UL class T
ACS350-03U-05A6-4	R1	16	gG	15	UL class T
ACS350-03U-08A8-4	R1	20	gG	25	UL class T
ACS350-03U-12A5-4	R3	25	gG	30	UL class T
ACS350-03U-15A6-4	R3	35	gG	35	UL class T
ACS350-03U-23A1-4	R3	50	gG	50	UL class T
ACS350-03U-31A0-4	R4	80	gG	80	UL class T
ACS350-03U-38A0-4	R4	100	gG	100	UL class T
ACS350-03U-44A0-4	R4	100	gG	100	UL class T

*) According to IEC-60269 standard.

Free space requirements

Enclosure type	Space above mm/in	Space below mm/in	Space on left/right mm/in
All frame sizes	75/3.83	75/3.83	0/0

Control connections



These connections are shown as examples only. Please refer to the *ACS350 User's Manual (3AFE68462401)* for more detailed information.

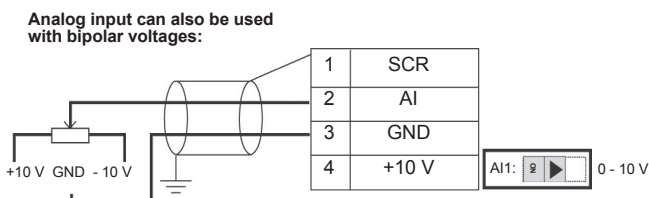
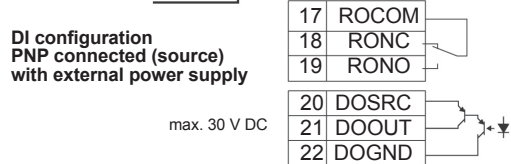
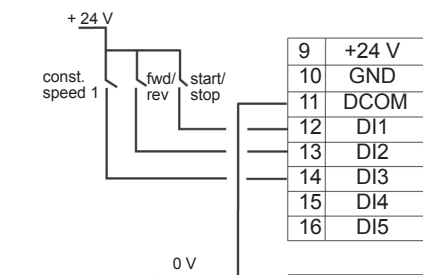
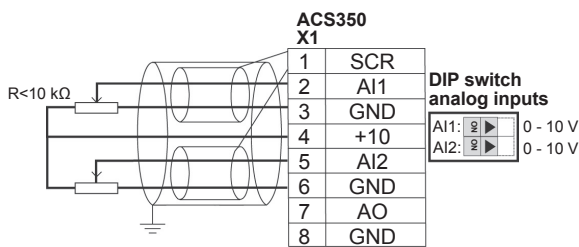
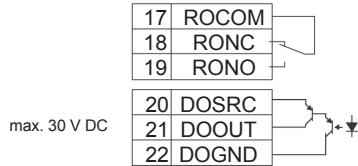
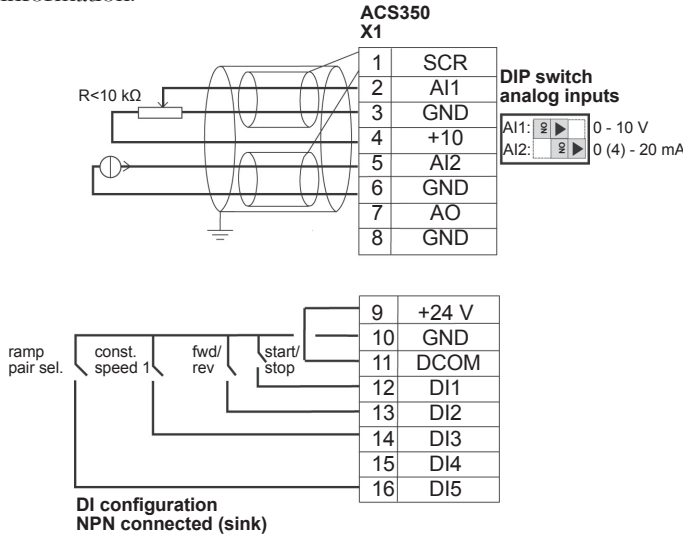

Default I/O connections

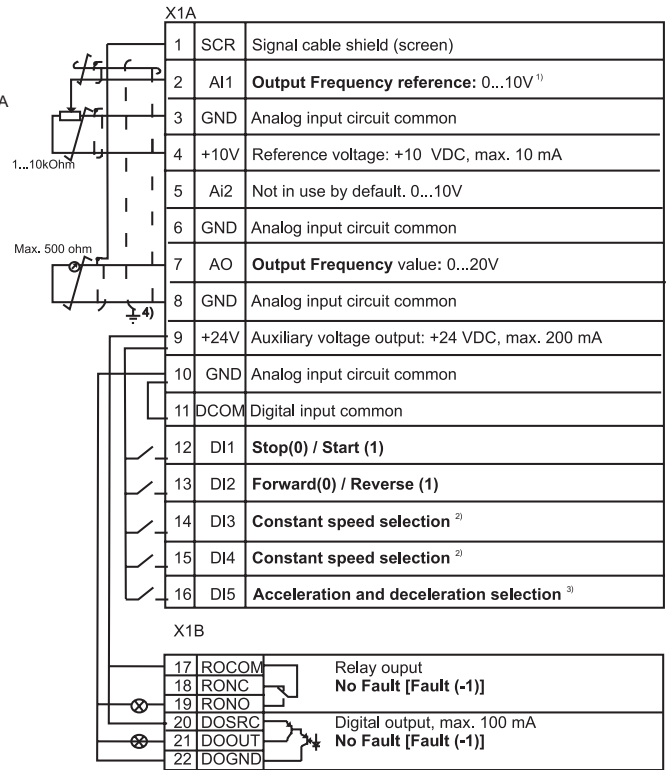

- 1) AI1 is used as a speed reference if vector mode is selected.
- 2) See parameter group 12 *Constant Speeds*:
- 3) 0 = ramp times according to parameters 2202 and 2203
1 = ramp times according to parameter 2205 and 2206
- 4) 360 degree grounding under a clamp.
Tightening torque = 0.5 Nm / 4.4 lbf. in

DI3	DI4	Operation (parameter)
0	0	Set speed through AI1
1	0	Speed 1 (1202)
0	1	Speed 2 (1203)
1	1	Speed 3 (1204)

PC to Panel Port Connection

Cable

Type: shielded CAT5e ethernet cable (STP)

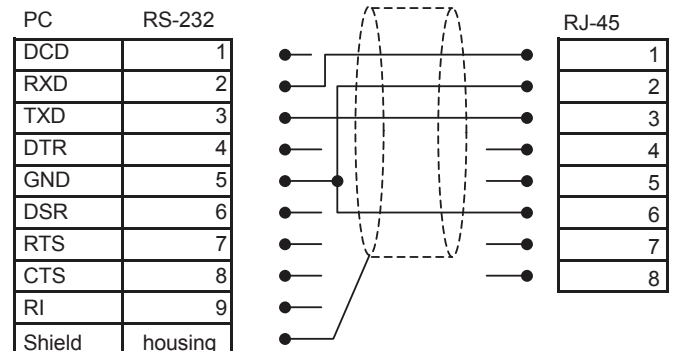

Notes



Notes





ABB Inc.

Low Voltage Drives
16250 W. Glendale Drive
New Berlin, WI 53151
Telephone (800) 752-0696
Fax (262) 785-0397
Internet <http://www.abb.us/drives>

ABB Inc.

Drives & LVC Canada
3299 J.B. Deschamps Blvd.
Lachine, Quebec
H8T 3E4
Telephone (800) 215-3006
Fax (514) 420-3137
Internet <http://www.abb.com/motors&drives>
<http://www.abb-drives.com>